



THE X6



# THE BMW X6.



# INNOVATION AND TECHNOLOGY.



18 Powertrain and Suspension



20 Driver Assistance  
21 Safety



22 Connectivity and Infotainment  
23 Comfort and Functionality

# EQUIPMENT.

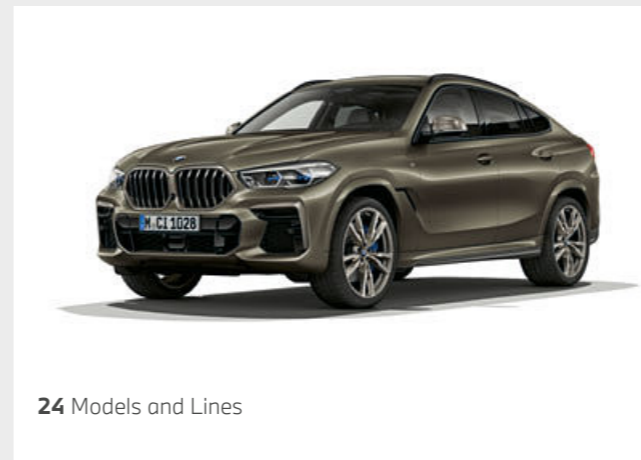

24 Models and Lines

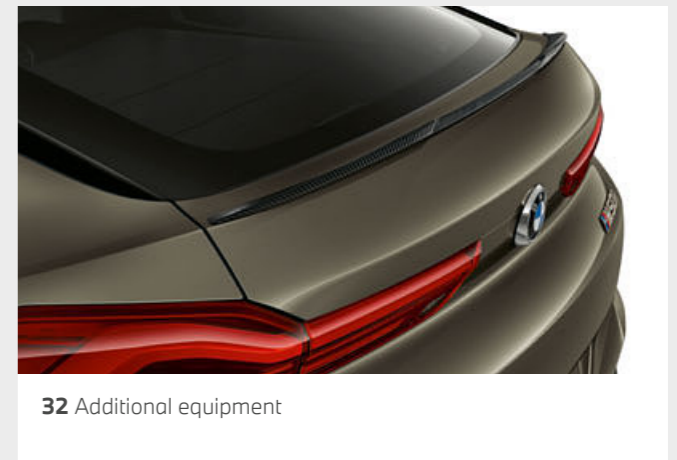

32 Additional equipment

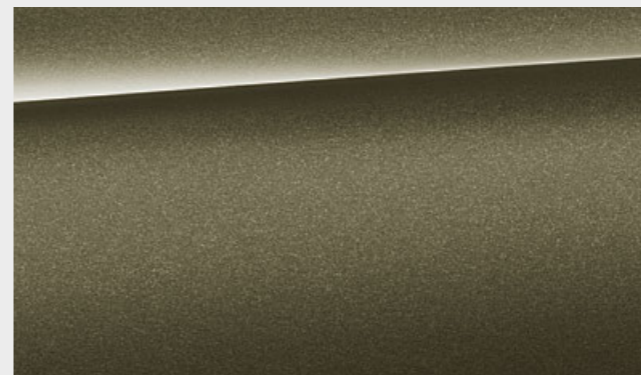

36 Exterior Colours

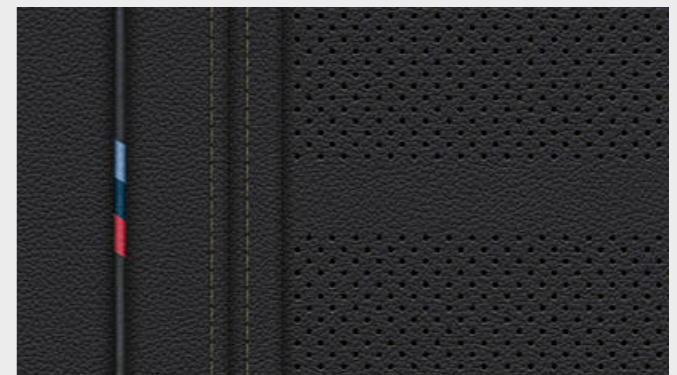

38 Interior Colours



## ALL BMW MODELS IN ONE APP.

DOWNLOAD THE **BMW Products** APP NOW AND  
DISCOVER THE PLEASURE OF DRIVING.



40 Wheels and Tyres



41 Original BMW Accessories

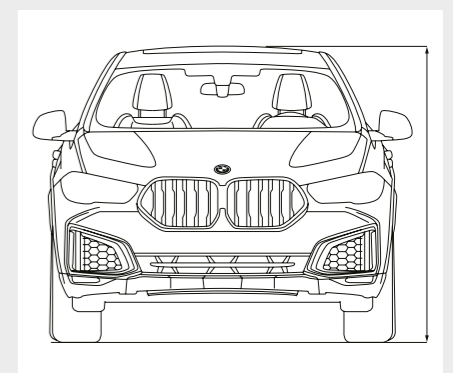

42 Technical data





THE ALPHA-BEAST.





THE MOST BEAUTIFUL  
EXPRESSION OF POWER.





FAR AND WIDE.  
NO CHALLENGE.





EXTRAEXTRAVAGANT.





MORE AUTHORITATIVE  
THAN EVER.





DYNAMICS  
ACROSS THE BOARD.

**NO IN & OUT  
ON  
SAME TICKET**  
TICKET NOT  
TRANSFERABLE  
VIOLATORS WILL  
BE TOWED AWAY AT  
VEHICLE OWNER'S  
EXPENSE

**AUTOMATED PARKING**  
OPEN 24 HOURS 7 DAYS A WEEK  
BY TICKET ONLY

**24 HOUR ASSISTANCE**  
CALL: 1-855-388-3496

**NO CHANGE GIVEN**  
INCLUDING ANY CITY PARKING TAGS

**INSTRUCTIONS:** INTERLOCKED  
@ BUDGET PARKING @ INTERLOCKED TAGS  
@ COLLECT TICKET @ INTERLOCKED TAGS  
@ BOOK BY TICKET @ INTERLOCKED TAGS  
@ NO TAGS @ INTERLOCKED TAGS  
@ NO TAGS @ INTERLOCKED TAGS

MOCI 1028

X5

xDrive35i





ATTRACTIVE  
POWERHOUSE.



■ Standard equipment □ Optional equipment



## ENGINE HIGHLIGHTS OF THE BMW X6.

### M50i

M TwinPower Turbo 8-cylinder petrol engine with 390 kW (530 hp) and 750 Nm torque  
Acceleration 0–100 km/h: 4.3 s  
Top speed: 250<sup>3</sup> km/h  
Fuel consumption, combined<sup>1,2</sup>: 12.0–11.2 l/100 km  
Combined CO<sub>2</sub> emissions<sup>1,2</sup>: 275–257 g/km

### xDrive40d<sup>4</sup> with mild hybrid technology

TwinPower Turbo 6-cylinder inline diesel engine with 250 kW (340 hp) and 700 Nm torque (plus 8 kW (11 hp) with mild hybrid technology)  
Acceleration 0–100 km/h: 5.5s  
Top speed: 248 km/h  
Fuel consumption, combined<sup>1,2</sup>: 7.9–6.8 l/100 km  
Combined CO<sub>2</sub> emissions<sup>1,2</sup>: 206–179 g/km

■ For maximum traction, driving dynamics and safety, the **BMW xDrive all-wheel drive system** provides variable drive power distribution to the front and rear axles.

□ The **Adaptive M suspension<sup>5,6,\*</sup>** with variable damper control allows the driver to choose between comfortable or sporty suspension settings.

□ The **Adaptive M suspension Professional\*** combines various technologies for optimum driving stability and dynamics.

□ The **M sport differential<sup>5,6,\*</sup>** optimises traction and driving stability when driving dynamically or on different road surfaces.

### DRIVING EXPERIENCE CONTROL

■ The Driving Experience Control features various different modes, so the driver can choose between a comfortable, particularly efficient or superbly athletic drive.

### ADAPTIVE 2-AXLE AIR SUSPENSION

□ The Adaptive 2-axle air suspension\* makes driving particularly comfortable with high driving dynamics and makes it easier to get in and out and load the vehicle. The air suspension automatically keeps the vehicle at a constant height regardless of the load. It can also be raised or lowered manually at the touch of a button.

### xOFFROAD PACKAGE

□ The BMW X6 features an xOffroad package\* that allows you to travel safely and quickly on the road as well as on less solid surfaces at all times. Four selectable off-road modes adapt the all-wheel drive xDrive even more precisely to the current driving surface – for even better traction on sand, rocks, gravel or snow.

### STEPTRONIC SPORT TRANSMISSION

■ The 8-speed Steptronic Sport transmission with Launch Control offers sporty gear changes, both automatically and manually via the selector lever or gearshift paddles – for comfortable cruising or dynamic driving. In SPORT mode and with the gear lever in the left-hand S/M position, the gear shifts are configured for maximum performance.

### INTEGRAL ACTIVE STEERING

□ Integral Active Steering boosts manoeuvrability and agility at lower speeds while improving stability at higher speeds.

### MILD HYBRID TECHNOLOGY

■ Mild hybrid technology<sup>4</sup> is used to recover braking energy and supports the combustion engine during acceleration with electric power. This reduces fuel consumption and emissions while giving you a dynamic advantage. The mild hybrid technology also makes the Automatic Start/Stop function much faster and much more comfortable.



<sup>1</sup> Performance data of petrol engines apply to vehicles using RON 98 fuel. Fuel consumption data apply to vehicles using reference fuels in accordance with EU Regulation 2007/715. Unleaded RON 91 and higher with a maximum ethanol content of 10% (E10) may also be used. BMW recommends RON 95 super unleaded petrol.

<sup>2</sup> Official data for fuel consumption and CO<sub>2</sub> emissions was determined in accordance with the prescribed measuring procedure and corresponds to European Regulation (EC) 715/2007 in the applicable version. For ranges, data determined as per WLTP takes into

account any optional equipment (available on the German market in this case). For vehicles that have been newly type approved since 1 January 2021, only the official data according to WLTP exists. For more information about NEDC and WLTP measuring procedures visit [www.bmw.com/wltp](http://www.bmw.com/wltp)

<sup>3</sup> Electronically limited.

<sup>4</sup> This engine version is not available in all countries. For further information, please contact your local BMW Partner.

<sup>5</sup> Available as standard for M50i and M50d.

<sup>6</sup> The engine version M50d is not available in all countries. For further information, please contact your local BMW Partner.

\*The availability of some equipment features and functions depends on engine variants or additional options. The market and production availability may vary. You can find detailed information about terms, standard and optional equipment at [www.bmw.com](http://www.bmw.com) or at your BMW Partner.



# DRIVER ASSISTANCE.

□ **Driving Assistant Professional<sup>1</sup>\*** offers optimum comfort and safety during critical or monotonous traffic situations. Apart from the contents of the Driving Assistant, it also includes Steering and Lane Control Assistant with extended functions, Lane Change and Emergency Stop Assistant and Lane Keeping Assistant with active side collision protection.

□ The **Steering and Lane Control Assistant\*** with extended functions can be activated to support you in monotonous traffic situations. It helps you to keep the vehicle in the centre of its lane, assists you in narrow places and, with active route guidance, makes navigation on motorways easier.

□ The **Crossing traffic warning front\*** warns you of crossing traffic when entering intersecting crossing traffic in unwieldy places. The system works up to a speed of 7 km/h and can be activated and deactivated via the "Park" setting menu.

□ **Parking Assistant Plus** makes parking and manoeuvring the vehicle easier. It features among others the Surround View system including Top View, Panorama View, Remote View 3D, as well as a lateral parking aid, the emergency braking function Active Park Distance Control, Parking Assistant with longitudinal and lateral guidance and Reversing Assistant.

□ The **Reversing Assistant\*** stores the last 50 m of the driven path in forward travel up to 35 km/h, so that it can be retracted if required. You are relieved of the steering work and can concentrate on monitoring the vehicle environment.

□ The **BMW Drive Recorder\*** allows you to record a video from the vehicle environment and play the video on the central Control Display or via USB export also on your device. Important vehicle information such as speed and GPS position are stored synchronously with the video. The BMW Drive Recorder has two sub-functions, the Event Recorder and the Crash Recorder.



# SAFETY.

■ Standard equipment □ Optional equipment



□ The **Crossing traffic warning rear\*** warns you of crossing traffic when pulling out of perpendicular parking spaces.

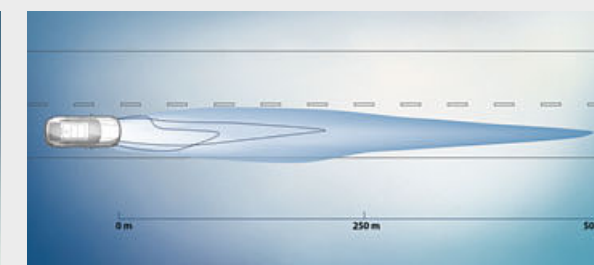

□ **BMW Laserlight** in a unique X design reaches a maximum illumination range of up to 500 m in laser high-beam mode.

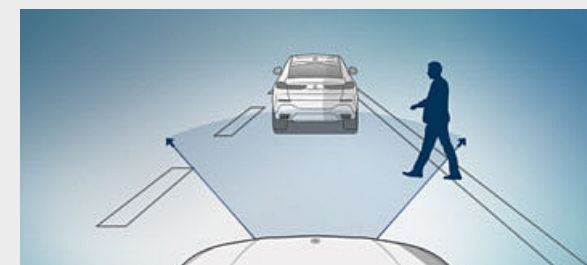

□ **Active Guard\*** includes the front collision warning with braking function and Lane Departure Warning.

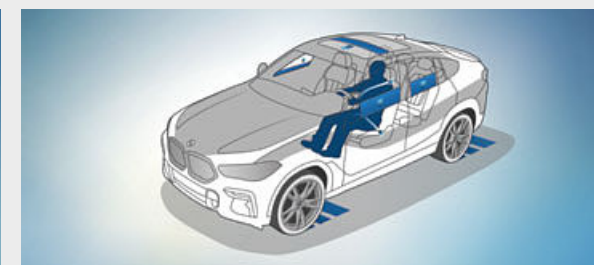

□ **Active Protection** takes precautions in critical situations and brakes the vehicle to a standstill after an accident.

\*The availability of some equipment features and functions depends on engine variants or additional options. The market and production availability may vary. You can find detailed information about terms, standard and optional equipment at [www.bmw.com](http://www.bmw.com) or at your BMW Partner.

<sup>1</sup> Function may be limited in darkness, fog or bright glare.



# COMFORT AND FUNCTIONALITY.

## BMW ConnectedDrive So connected, you're free.



### CONNECTED MUSIC

□ Listen to your favourite music wherever you are. Classical on the motorway, jazz during rush hour and pop when you're cruising. Connected Music<sup>1</sup> with Spotify means you can directly stream countless millions of songs without any limits via BMW's music partner Spotify, using the SIM card installed in your vehicle.

### REMOTE SOFTWARE UPGRADE

■ The latest software version always on board. With Remote Software Upgrade, your BMW will always be up to date. You can simply download the upgrades via the My BMW App or via the SIM card installed in the vehicle and then install them. In this way, other available functions in your BMW are also activated.

### BMW INTELLIGENT PERSONAL ASSISTANT

■ Wouldn't it be incredible if your BMW was also your personal vehicle expert? Communicate with your vehicle using the BMW Intelligent Personal Assistant\*. Say natural commands to operate numerous vehicle functions. It can also explain topics about your vehicle and helps you to get to know your BMW even better.

### PARKING PLACE ASSIST

□ Trying to find a parking space close to your destination? This is an easy task with the Parking Space Assistant\*. It suggests vacant spaces in large parking facilities or on the street and, based on your selection, finds the best route for you with the highest likelihood of an available space.

### BMW DIGITAL KEY

□ No need to take the key with you as long as you have your iPhone with you. You can lock and unlock your BMW and even start it with the BMW Digital Key<sup>2</sup>\*. You can also authorise up to five people with compatible iPhones to use your BMW. Among other things, the maximum speed can be limited – ideal for novice drivers.

### CONNECTED PACKAGE PROFESSIONAL

□ Concierge Service, Remote Services, smartphone integration incl. Apple CarPlay and Android Auto, In-Car Experiences, Connected Music or BMW Maps with Connected Navigation and Connected Parking? Get them all! With the Connected Package Professional\*, you can get these BMW ConnectedDrive services as well as BMW Music to test free of charge.

<sup>2</sup> Prerequisite is a BMW ConnectedDrive account and a compatible smartphone. For customers with a non-compatible smartphone, a high-quality Key Card is provided. More information about the BMW Digital Key, e.g. regarding the compatibility of your smartphone, is available at [www.bmw.com/digitalkey](http://www.bmw.com/digitalkey)

<sup>1</sup> Depending on availability, the partner Spotify will come into the vehicle via Remote Software Upgrade.

# COMFORT AND FUNCTIONALITY.

■ Standard equipment □ Optional equipment

□ The **luggage-compartment package** includes not only flexible fastening nets, a tensioning strap and the slide and anti-slip rails in the luggage compartment, but also the flex net, which can be attached to various eyelets and can also be used as a shopping bag.

□ The **Ambient Air Package** comprises a fragrance dispersal function and an air ionisation function. There are several fragrances to choose from, all specially composed for the vehicle. Two of them can be used in parallel and selected alternately.

□ When open, the **Panorama glass roof** provides a great deal of fresh air. Closed, it creates a bright, light-flooded atmosphere in the interior. It opens and closes completely automatically at the push of a button or with the vehicle key, and is equipped with slide and lift functions, roller sunblind and wind deflector.

□ The **acoustic glazing\*** on the front side windows complements the acoustic glazing on the front windscreen and significantly reduces the level of noise for everyone inside the vehicle. It minimises noise created by the outside surroundings and flow of air, as well as by the engine, tyres and windscreen wipers. Music listeners and hands-free device users in particular will appreciate the difference this makes.

□ The **Massage function\*** for driver and passenger improves the physical wellbeing by stimulating or relaxing certain muscle groups. There are several massage programmes dedicated to different parts of the body.



Some ConnectedDrive Services may differ between countries. Please consult your local BMW partner for more information.

\* The availability of some equipment features and functions depends on engine variants or additional options. The market and production availability may vary. You can find detailed information about terms, standard and optional equipment at [www.bmw.com](http://www.bmw.com) or at your BMW Partner.



# BASE.

Discover even more with the new BMW Products app. Available now, for your smartphone and tablet.



■ The black Sport leather steering wheel with three spokes features a Chrome decorative trim. A thick rim and contoured thumb rests provide an exceptionally pleasant, high-grip feel. The airbag cover is also finished in leather.

■ Dynamic and comfortable: the standard and individually adjustable Sport seats for the driver and front passenger feature numerous electric adjustment options, including backrest width and seat angle. Together with adjustable thigh support, the taller seat and backrest bolsters provide excellent ergonomics and more lateral support during fast cornering.

## Selected base model equipment features:

- 19" light alloy wheels V-spoke style 734
- Leather 'Vernasca' design-perforated
- Interior trim finishers Aluminium 'Mesheffect' dark
- BMW Live Cockpit Professional with 12.3" instrument cluster and 12.3" Control Display
- Ambient lighting
- Adaptive LED headlights
- Steptronic Sport transmission
- Sport seats for driver and front passenger incl. electrical seat adjustment with memory
- Sport leather steering wheel
- 2.5-zone automatic air conditioning
- Instrument panel in Sensatec



■ 19" light alloy wheels V-spoke style 734, Reflex Silver with run-flat tyres, wheel size 9J x 19 with 265/50 R19 tyres.

# xLINE.

Equipment 24 | 25

■ Standard equipment □ Optional equipment

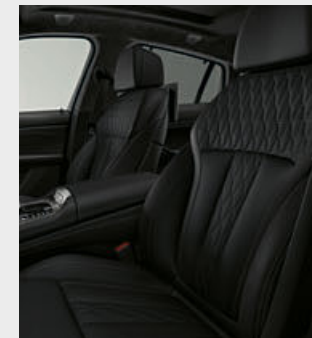

■ The black Sport leather steering wheel with a thick rim and contoured thumb rests has an exceptionally pleasant, high-grip feel.

□ The comfort seats for driver and front passenger can be adjusted electrically in a variety of ways and provide a perfect seating position for a relaxed arrival.

■ 20" light alloy wheels V-spoke style 738 Bicolour Ferric Grey with mixed tyres and runflat properties, gloss-lathed, front 9J x 20 with 275/45 R20 tyres, rear 10.5J x 20 with 305/40 R20 tyres.

□ 21" light alloy wheels Y-spoke style 744 Bicolour Orbit Grey with mixed tyres and runflat tyres\*, gloss-lathed, front 9.5J x 21 with 275/40 R21 tyres, rear 10.5J x 21 with 315/35 R21 tyres.

## xLine exterior equipment:

- BMW kidney grille with exclusively designed vertical slats with front sides and grille frame in Aluminium satinised look
- 20" light alloy wheels V-spoke style 738 Bicolour; other wheels available
- BMW Individual Exterior Line in Aluminium satinised, alternatively M high-gloss Shadow Line
- Specific air intakes in Aluminium satinised look
- Side sill trim with trim strip in Aluminium satinised
- Rear apron with design elements in Aluminium satinised look
- Roof rails Aluminium satinised, alternatively M roof rails high-gloss Shadow Line

## xLine interior equipment:

- Vehicle key with Chrome detailing

\*The availability of some equipment features and functions depends on engine variants or additional options. The market and production availability may vary. You can find detailed

information about terms, standard and optional equipment at [www.bmw.com](http://www.bmw.com) or at your BMW Partner.



# M SPORT PACKAGE.

powered by  Discover even more with the new BMW Products app. Available now, for your smartphone and tablet.

■ Standard equipment □ Optional equipment



■ The M Leather steering wheel including multifunction buttons, an M badge and an integrated driver-side airbag is featured in three-spoke design. With a steering wheel rim in leather 'Walknappa' Black with black stitching and contoured thumb rests, it provides a direct, athletic steering experience.



□ The M Multifunctional seats\* for the driver and front passenger in exclusive design and with M logo on the headrest reflect the vehicle's athletic look. Lower seat bases and high side bolsters emphasize the shell-seat look and guarantee flawless lateral support. Accompanied by a comprehensive range of adjustment possibilities, maximum comfort is achieved.

## M Sport package exterior equipment:

- M Aerodynamics package with front apron, side sills and wheel arch trims in body colour
- 20" M light alloy wheels Star-spoke style 740 M in Bicolour with mixed tyres and run-flat tyres; other wheels available
- Adaptive M suspension; other suspensions available
- Steptronic Sport transmission
- M high-gloss Shadow Line, alternatively BMW Individual Exterior Line Aluminium satinised
- M designation on the sides
- M Sport brake with blue painted brake calipers with M designation
- Rear apron with diffuser insert
- M Sport package specific rear spoiler
- M Sport exhaust system
- Tailpipe trim strip in M Sport package specific geometry
- Exclusive paintwork in M Carbon Black metallic; other paintwork available

## M Sport package interior equipment:

- M door sill finishers, illuminated, M driver footrest and M specific pedals
- Sport seats for the driver and front passenger in leather 'Vernasca' black with M signature; other upholsteries available
- M leather steering wheel
- M anthracite headliner
- Interior trim finishers in Aluminium 'Mesheffect' dark, alternatively M Sport package specific M interior trim finishers in Aluminium Tetragon; other trims available
- Instrument cluster with M specific display in SPORT and SPORT+ mode
- M Sport package specific vehicle key
- M specific floor mats in velour\*



■ 20" M light alloy wheels Star-spoke style 740 M Bicolour Orbit Grey with mixed tyres and runflat tyres, gloss-lathed, front 9J x 20 with 275/45 R20 tyres, rear 10.5J x 20 with 305/40 R20 tyres.



□ 22" M light alloy wheels Double-spoke style 742 M Bicolour Jet Black with mixed tyres, gloss-lathed, front 9.5J x 22 with 275/35 R22 tyres, rear 10.5J x 22 with 315/30 R22 tyres.

\*The availability of some equipment features and functions depends on engine variants or additional options. The market and production availability may vary. You can find detailed information about terms, standard and optional equipment at [www.bmw.com](http://www.bmw.com) or at your BMW Partner.



# THE BMW X6 M50i.

Even more – of everything: The BMW X6 M50i further intensifies the already unmistakable character of the BMW X6 in every respect. Equipped with the most powerful engine of the BMW X6 series – and the unmistakable sound from the M Sport exhaust system – it dominates the road from the very first metre. Thanks to a specifically tuned Adaptive M suspension, precise steering and an M Sport differential that improves traction, it easily makes competitors disappear in the rear-view mirror. Such a strong personality naturally also enjoys an unforgettable appearance: Specific features such as kidney grille slats, exterior mirror caps, model lettering and tailpipe trims in the M signature colour Cerium Grey set the standard for absolute athleticism. At the same time, design details such as model designations on the illuminated door sill finishers, in the instrument cluster, on the engine cover and at the rear leave no doubt about the absolute high-performance ambitions of the BMW X6 M50i.

■ Standard equipment □ Optional equipment



□ An unmistakable sight from the front: A special highlight is the lighting of the typical BMW double kidney grille. With kidney grille slats and a kidney grille frame in the M signature colour Cerium Grey, the front of the BMW X6 M50i is both elegant and consistently sporty.



■ All door sill finishers are not only illuminated, but also bear the "M50i" model designation.



■ The trapezoidal tailpipes are painted in the M signature colour Cerium Grey and already visually arouse the desire for the rich sound of the M Sport exhaust system.



■ A top athlete conveying pure driving pleasure: The M TwinPower Turbo 8-cylinder petrol engine features superior power delivery and the striking, characteristic M engine sound. Two turbochargers, fully variable Valvetronic valve control and high precision injection petrol direct injection ensure outstanding performance.



# BMW INDIVIDUAL.

THE EXPRESSION OF PERSONALITY.



The paint finish in BMW Individual Ametrine metallic makes an unmistakable self-confident statement. It contains the effect pigment Xirallic, which, depending on the intensity of the light, creates a fascinating glitter in countless shades of the gemstone that gives it its name.



Fine, aristocratic, timeless: The BMW Individual full leather trim Merino Black is a sign of a personality that appreciates something special.



The interior trim finishers in BMW Individual fine-wood trim Finesse black with aluminium inserts are characterised by their extremely high-quality appearance. Each grain is adapted specifically for each vehicle, emphasising the high craftsmanship ambitions of BMW Individual.

If someone decides, then you: BMW Individual offers you all the options to customise the BMW X6 according to your wishes, with the degree of customisation entirely up to you. Add your personal driving experience to the typical BMW driving pleasure. Choose what suits you the most from particularly high-quality equipment options: Exclusive BMW Individual paint finishes that show style and confidence. Soft, substantial leather trims and interior trim made of fine woods, which turn the vehicle interior into your personal comfort zone. Or go your very own way, only following your ideas – BMW Individual ensures that they will become an automotive reality.



# ADDITIONAL EQUIPMENT.

Discover even more with the new BMW Products app. Available now, for your smartphone and tablet.

■ Standard equipment □ Optional equipment



□ The BMW kidney grille 'Iconic Glow' sets impressive visual highlights. With its innovative LED fibre technology, it enables sensational white light scenarios – for example while driving or when opening and closing your vehicle.



■ The rear lights are made up of individual high-performance LED lighting elements. They have the characteristic, striking BMW L-shape, meaning that the vehicle is clearly recognisable as a BMW even in the dark.



□ The M high-gloss Shadow Line with extended features includes the BMW kidney grille as well as the tailpipe trims in Black high-gloss, with the side flanks of the kidney grille frame in satinised aluminium.



□ The M Carbon\* rear spoiler emphasises the vehicle's powerful, sporty design and noticeably reduces unwanted aerodynamic uplift on the rear axle.



□ The M Carbon\* mirror caps emphasise the powerful, sporty design of the vehicle.



□ In laser high-beam mode, BMW Laserlight in a unique X design illuminates a range of up to 500 m, nearly twice as far as that of conventional headlights. Better visibility in the dark significantly increases safety. The blue X signature and the "BMW Laser" lettering underline the vehicle's technological standards.



□ In warm weather, the Active seat ventilation, front\* provides a cool and pleasant seat temperature, resulting in a more comfortable driving experience. Air vents in the seat surfaces and backrests suck air. The intensity of the airflow can be adjusted. The perforated surfaces are made of leather 'Vernasca'.



□ The BMW Individual Exterior Line Satin Aluminium creates luxurious highlights with window recess finishers, side frame trim strips and the air breather in silky matt brushed Aluminium. To create contrast, many design details are finished in Black high-gloss or, depending on the equipment and engine, Black grained.



□ The M high-gloss Shadow Line<sup>1,2</sup> includes numerous equipment details in Black high-gloss: side frame trim strips, window recess finishers, B- and C-pillars, window guide bars and mirror triangles.

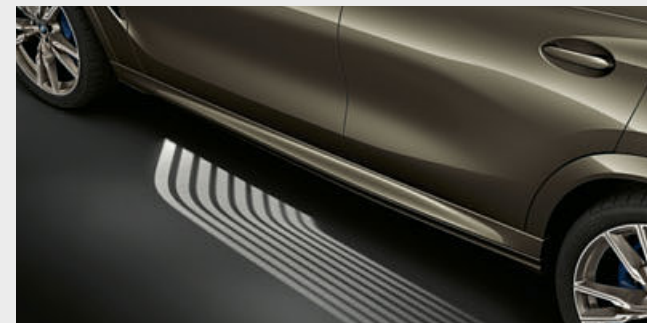

■ The Welcome Light Carpet function projects an ambient light graphic in front of the vehicle doors and creates a surrounding welcome ambience right at the entrance. The light carpet also makes getting out in the dark even more comfortable and safe.



□ The 'CraftedClarity' glass application comprises hand-made glass elements that visually and tactilely enhance the interior. The details of the gear selector, iDrive Controller and Start/Stop button are made of fine crystal.

<sup>1</sup> Available as standard for M50i and M50d.

<sup>2</sup> The engine version M50d is not available in all countries. For further information, please contact your local BMW Partner.

\*The availability of some equipment features and functions depends on engine variants or additional options. The market and production availability may vary. You can find detailed information about terms, standard and optional equipment at [www.bmw.com](http://www.bmw.com) or at your BMW Partner.



# ADDITIONAL EQUIPMENT.

Discover even more with the new BMW Products app. Available now, for your smartphone and tablet.

■ Standard equipment □ Optional equipment



□ Concierge Service, Remote Services, smartphone integration incl. Apple CarPlay and Android Auto, In-Car Experiences, Connected Music or BMW Maps with Connected Navigation and Connected Parking? Get them all! With the Connected Package Professional\*, you can get these BMW ConnectedDrive services as well as BMW Music to test free of charge.

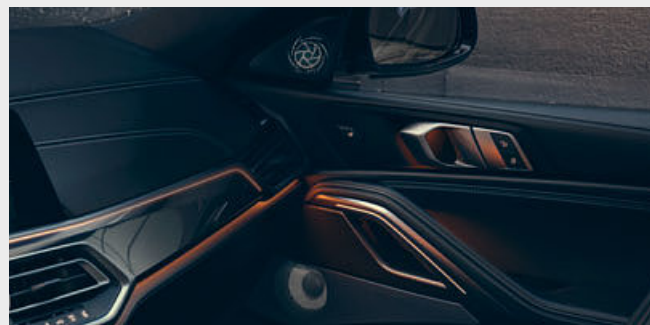

□ The Bowers & Wilkins Diamond surround sound system\* with two diamond tweeters features outstanding studio-quality sound for every seat in the vehicle. 20 carefully positioned speakers with a total output of 1,500 watts provide a mesmerising sound experience. Individual speakers are highlighted with specific illumination, visually emphasising the system's outstanding sound quality.

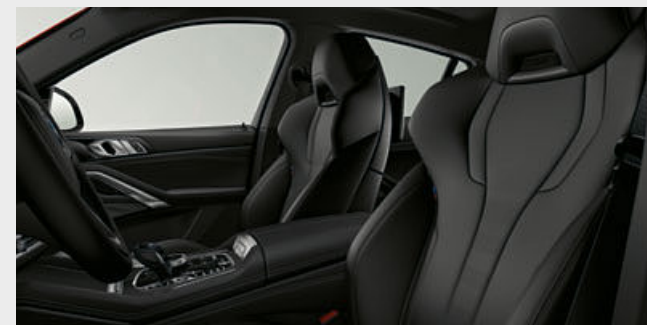

□ The M Multifunctional seats\* for the driver and front passenger in exclusive design and with M logo on the headrest reflect the vehicle's athletic look. Lower seat bases and high side bolsters emphasize the shell-seat look and guarantee flawless lateral support. Accompanied by a comprehensive range of adjustment possibilities, maximum comfort is achieved.



□ The comfort seats for driver and front passenger include active headrests and can be electrically adjusted in various ways. The top part of the backrest, the backrest width, thigh support and headrest height can be individually adjusted. The equipment package range also includes the lumbar support and memory function for the driver.

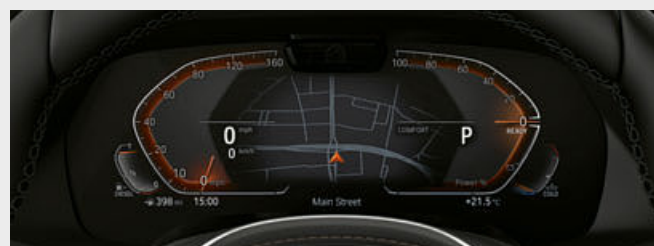

■ The BMW Live Cockpit Professional with navigation function<sup>1</sup> includes two high-quality displays consisting of a high-resolution 12.3" Control Display that can be operated by touch and a fully digital 12.3" instrument display.



□ The full-colour BMW Head-Up Display<sup>2</sup> projects all information relevant to the journey directly into your field of vision, allowing you to fully concentrate on driving. Information such as the current speed, navigation directions, speed limit info including no-overtaking indicator, along with telephone and entertainment lists are displayed, depending on the equipment.

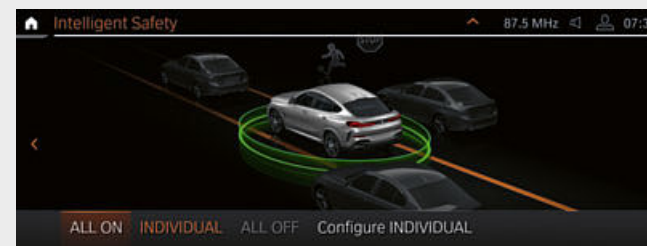

□ Driving Assistant Professional<sup>3</sup>\* offers optimum comfort and safety during critical or monotonous traffic situations. Apart from the contents of the Driving Assistant, it also includes Steering and Lane Control Assistant with extended functions, Lane Change and Emergency Stop Assistant and Lane Keeping Assistant with active side collision protection.



□ The BMW Drive Recorder\* allows you to record a video from the vehicle environment and play the video on the central Control Display or via USB export also on your CE device. Important vehicle information such as speed and GPS position are stored synchronously with the video. The Drive Recorder has two sub-functions, the Event Recorder and the Crash Recorder.



□ The temperature-controlled cupholders in the centre console can individually cool or keep stored beverages warm. The temperature control is activated via buttons on the left and right. The ambient lighting also indicates the function (blue for cooling or red for heating).



□ Rear-seat Entertainment Professional includes two separate high-resolution 10.2" colour screens with touch function that can be tilted and a Blu-ray drive. In this way, it becomes possible to use navigation and internet functions while driving (if a mobile phone contract exists). Additionally, a USB port and connections for MP3 players, game consoles and headphones (even wireless) are included.

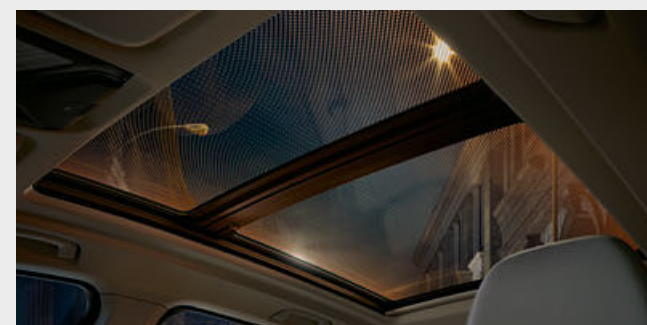

□ The Panorama glass roof Sky Lounge creates a generous sense of space during the day, while at night it lends an atmospheric mood with a light design consisting of more than 15,000 light elements. The light design can be switched between six Ambient light colours.



■ The standard Ambient light, including Ambient contour lighting in the front and rear doors, creates a relaxed, cosy lighting atmosphere in the interior. The Welcome Light Carpet illuminates the area in front of the vehicle doors when entering and exiting. Six dimmable light designs in White, Blue, Orange, Bronze, Lilac and Green are available.

<sup>1</sup> As part of BMW ConnectedDrive, in selected European countries the system automatically updates domestic maps up to four times per year, for a period of three years.

<sup>2</sup> The information in the BMW Head-Up Display is not fully visible when viewed through

polarised sunglasses. Content shown will depend on the equipment options chosen. Further optional equipment is required to display specific items.

<sup>3</sup> Function may be limited in darkness, fog or bright glare.

Some ConnectedDrive Services may differ between countries. Please consult your local BMW partner for more information.

\*The availability of some equipment features and functions depends on engine variants or additional options. The market and production availability may vary. You can find detailed information about terms, standard and optional equipment at [www.bmw.com](http://www.bmw.com) or at your BMW Partner.



# EXTERIOR COLOURS.

Discover even more with the new BMW Products app. Available now, for your smartphone and tablet.

■ Standard equipment □ Optional equipment



□ Non-metallic 300 Alpine White<sup>1,4</sup>

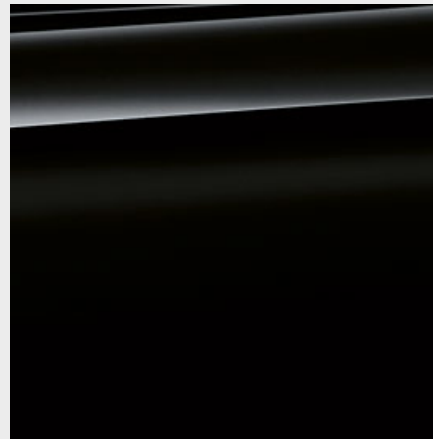

■ Non-metallic 668 Black<sup>2,4</sup>



□ Metallic A96 Mineral White<sup>3</sup>

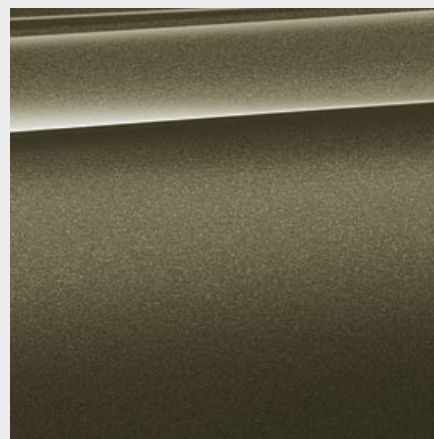

□ Metallic C3D Manhattan<sup>3</sup>



□ Metallic B53 Sparkling Brown

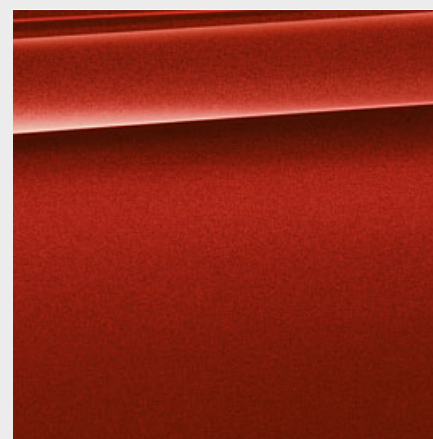

□ Metallic C06 Flamenco Red brilliant effect<sup>3</sup>



□ Metallic C27 Arctic Grey brilliant effect<sup>3</sup>



□ Metallic A90 Sophisto Grey Brilliant Effect<sup>2,4</sup>

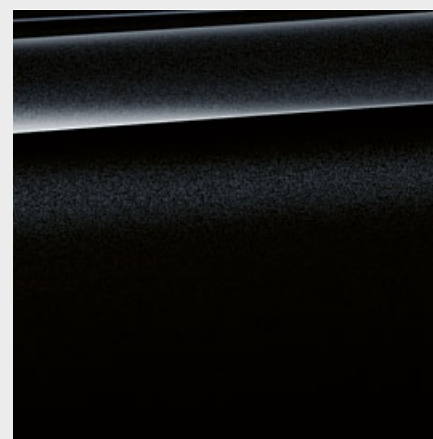

□ Metallic 475 Black Sapphire<sup>3</sup>

## BMW INDIVIDUAL

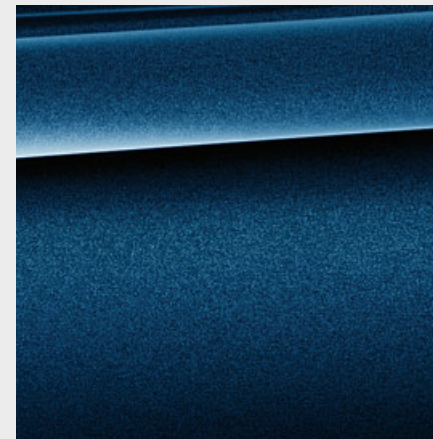

□ BMW Individual C3Z Tanzanite Blue metallic<sup>3</sup>

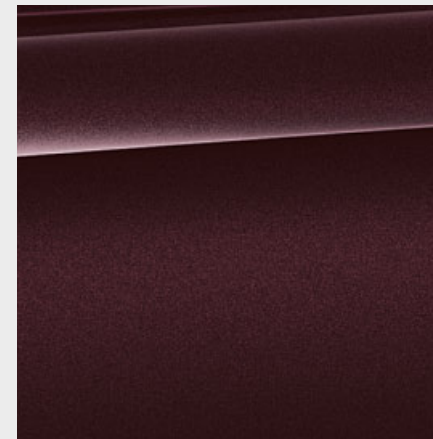

□ BMW Individual X1B Ametrine metallic<sup>3</sup>



□ BMW Individual C36 Dravit Grey metallic<sup>3</sup>

## M SPORT PACKAGE

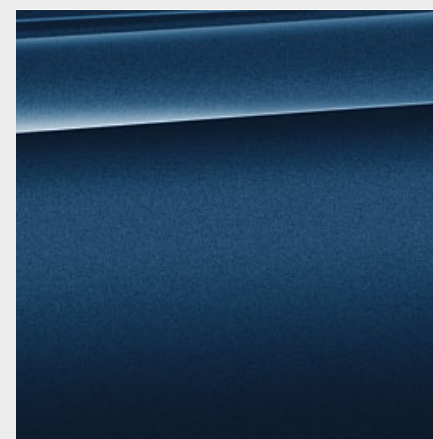

□ Metallic C1M Phytionic Blue

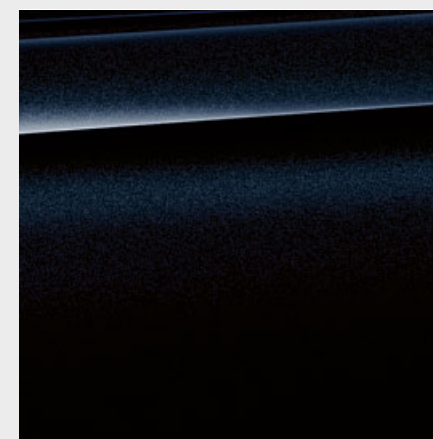

□ Metallic 416 M Carbon Black

**[Colour samples]** These colour samples are intended as an initial guide to the colours and materials available for your BMW. However, experience has shown that printed versions of paint, upholstery and interior trim colours cannot in all cases faithfully reproduce the

appearance of the original colour. Please discuss your preferred colour choices with your BMW partner or in your dealership. There you can also see original samples and be assisted with special requests.

<sup>1</sup> Available as standard for M Sport package, M50i and M50d.  
<sup>2</sup> Not available for M50i and M50d.

<sup>3</sup> Also optionally available for the M Sport package.

<sup>4</sup> The engine version M50d is not available in all countries. For further information, please contact your local BMW Partner.

The availability of some equipment features and functions depends on engine variants or additional options. The market and production availability may vary. You can find detailed information about terms, standard and optional equipment at [www.bmw.com](http://www.bmw.com) or at your BMW Partner.



# INTERIOR COLOURS.

Discover even more with the new BMW Products app. Available now, for your smartphone and tablet.

■ Standard equipment □ Optional equipment

## LEATHER

Available with



- Base
- xLine
- M Sport package

Leather 'Vernasca' MCEW design-perforated Ivory White, interior colour Black



- Base
- xLine
- M Sport package

Leather 'Vernasca' MCR1 design-perforated Cognac, interior colour Black



- Base
- xLine
- M Sport package

Leather 'Vernasca' MCFY design-perforated Canberra Beige, interior colour Black<sup>1,\*</sup>



- Base
- xLine
- M Sport package

Leather 'Vernasca' MCHF design-perforated Coffee, interior colour Black



- Base
- xLine
- M Sport package

Leather 'Vernasca' MCG7 design-perforated Tacora Red, interior colour Black

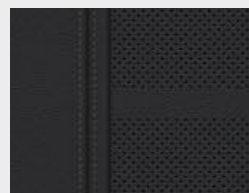

- Base
- xLine
- M Sport package

Leather 'Vernasca' MCSW design-perforated Black, interior colour Black

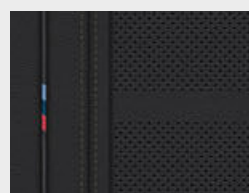

- M Sport package

Leather 'Vernasca' MAH9 Black, contrast stitching Brown incl. M signature, interior colour Black

## BMW INDIVIDUAL LEATHER

Available with



- Base
- xLine
- M Sport package

BMW Individual full leather trim 'Merino' ZBEW Ivory White\*



- Base
- xLine
- M Sport package

BMW Individual extended leather trim 'Merino' VAEW Ivory White, interior colour Black



- Base
- xLine
- M Sport package

BMW Individual extended leather trim 'Merino' VAHF Coffee, interior colour Black

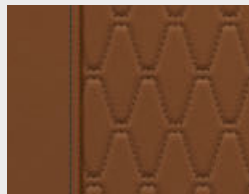

- Base
- xLine
- M Sport package

BMW Individual full leather trim 'Merino' ZBTQ Tartufo\*

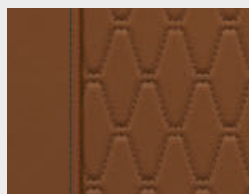

- Base
- xLine
- M Sport package

BMW Individual extended leather trim 'Merino' VATQ Tartufo, interior colour Black<sup>1,\*</sup>

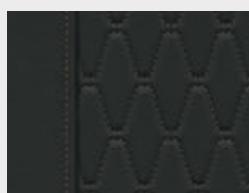

- Base
- xLine
- M Sport package

BMW Individual full leather trim 'Merino' ZBSW Black, interior colour Black\*

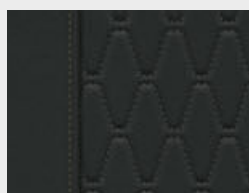

- Base
- xLine
- M Sport package

BMW Individual extended leather trim 'Merino' VASW Black, interior colour Black\*

## INTERIOR TRIM FINISHERS

Available with



- M Sport package

M interior trim finishers Aluminium Tetragon<sup>1,2</sup>

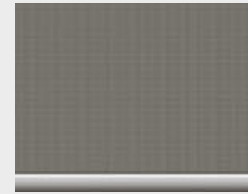

- Base
- xLine
- M Sport package

Interior trim finishers Aluminium 'Mesheffect' dark

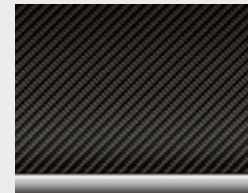

- M Sport package

M interior trim finishers 'Carbon Fibre' with highlight trim finisher Pearl Chrome

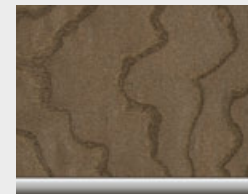

- Base
- xLine
- M Sport package

Fine-wood trim Ash Grain brown-metallic high-gloss

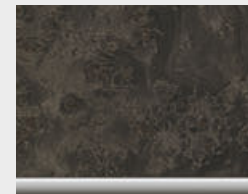

- Base
- xLine
- M Sport package

Fine-wood trim poplar grain anthracite-brown open-pored

## BMW INDIVIDUAL INTERIOR TRIM FINISHERS

Available with



- Base
- xLine
- M Sport package

BMW Individual interior trim finishers piano finish Black



- Base
- xLine
- M Sport package

BMW Individual fine-wood trim 'Fineline' Black with Aluminium inserts



- Base
- xLine
- M Sport package

BMW Individual interior trim finishers fine-wood trim Ash Grain Silver Grey high-gloss

## M HEADLINER

Available with

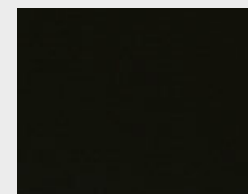

- Base
- xLine
- M Sport package

M headliner 775 Anthracite<sup>1,2</sup>

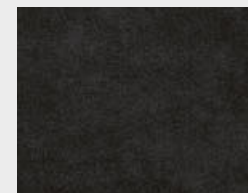

- Base
- xLine
- M Sport package

M headliner 776 Alcantara Anthracite

Please note that even normal long- or short-term use can lead to unrecoverable upholstery damage. This can be caused in particular by non-colourfast clothing.

Please note that the interior colour depends on the selected upholstery colour.

<sup>1</sup> Available as standard for M50i and M50d.

<sup>2</sup> The engine version M50d is not available in all countries. For further information, please contact your local BMW Partner.

\* The availability of some equipment features and functions depends on engine variants or additional options. The market and production availability may vary. You can find detailed information about terms, standard and optional equipment at [www.bmw.com](http://www.bmw.com) or at your BMW Partner.



# WHEELS AND TYRES.

Discover even more with the new BMW Products app. Available now, for your smartphone and tablet.



■ 19" light alloy wheels V-spoke style 734 in Reflex Silver\*, wheel size 9J x 19 with 265/50 R19 tyres.



□ 20" light alloy wheels Star-spoke style 736 Ferric Grey with mixed tyres and runflat tyres\*, front 9J x 20 with 275/45 R20 tyres, rear 10.5J x 20 with 305/40 R20 tyres.



■ 20" light alloy wheels V-spoke style 738 Bicolour Ferric Grey with mixed tyres and runflat properties\*, gloss-lathed, front 9J x 20 with 275/45 R20 tyres, rear 10.5J x 20 with 305/40 R20 tyres.<sup>1</sup>



■ 20" M light alloy wheels Star-spoke style 740 M Bicolour Orbit Grey with mixed tyres and runflat tyres\*, gloss-lathed, front 9J x 20 with 275/45 R20 tyres, rear 10.5J x 20 with 305/40 R20 tyres.<sup>2</sup>



□ 21" M light alloy wheels Y-spoke style 741 M Bicolour Orbit Grey with mixed tyres, gloss-lathed, front 9.5J x 21 with 275/40 R21 tyres, rear 10.5J x 21 with 315/35 R21 tyres.<sup>2,3,6</sup>



□ 21" light alloy wheels Y-spoke style 744 Orbit Grey with mixed tyres and runflat tyres\*, front 9.5J x 21 with 275/40 R21 tyres, rear 10.5J x 21 with 315/35 R21 tyres.<sup>4</sup>



□ 21" light alloy wheels Y-spoke style 744 Bicolour Orbit Grey with mixed tyres and runflat tyres\*, gloss-lathed, front 9.5J x 21 with 275/40 R21 tyres, rear 10.5J x 21 with 315/35 R21 tyres.



□ 22" M light alloy wheels Double-spoke style 742 M Bicolour Jet Black with mixed tyres, gloss-lathed, front 9.5J x 22 with 275/35 R22 tyres, rear 10.5J x 22 with 315/30 R22 tyres.<sup>2</sup>



□ 22" M light alloy wheels Double-spoke style 742 M Jet Black with mixed tyres, front 9.5J x 22 with 275/35 R22 tyres, rear 10.5J x 22 with 315/30 R22 tyres.<sup>2</sup>



□ 22" M light alloy wheels V-spoke style 747 M Cerium Grey matt with mixed tyres, gloss-lathed, front 9.5J x 22 with 275/35 R22 tyres, rear 10.5J x 22 with 315/30 R22 tyres.<sup>5,6</sup>



□ 22" BMW Individual light alloy wheels V-spoke style 746 I Orbit Grey with mixed tyres, gloss-lathed, front 9.5J x 22 with 275/35 R22 tyres, rear 10.5J x 22 with 315/30 R22 tyres.

<sup>1</sup> Only available in conjunction with xLine.  
<sup>2</sup> Only available in conjunction with M Sport package.  
<sup>3</sup> Available as standard for M50i and M50d.  
<sup>4</sup> Only available in conjunction with base and xLine.  
<sup>5</sup> Exclusively available for M50i and M50d.

<sup>6</sup> The engine version M50d is not available in all countries. For further information, please contact your local BMW Partner.

\* The availability of some equipment features and functions depends on engine variants or additional options. The market and production availability may vary. You can find detailed information about terms, standard and optional equipment at [www.bmw.com](http://www.bmw.com) or at your BMW Partner.

# ORIGINAL BMW ACCESSORIES.

■ Standard equipment □ Optional equipment ○ Accessories



○ This contemporary roof box in Black with titanium silver side trims has a 520-litre capacity and fits all BMW roof rack systems. It can be opened from both sides and features triple central locking on each side which makes it easy to load and provides anti-theft locking.



○ The BMW Advanced Car Eye 2.0 is a highly sensitive full-HD camera that watches over events in front of and behind the car, even when it is parked. In the event of disturbances and extraordinary movement outside the vehicle, the camera automatically records the situation in order to document possible accidents or (attempted) break-ins.

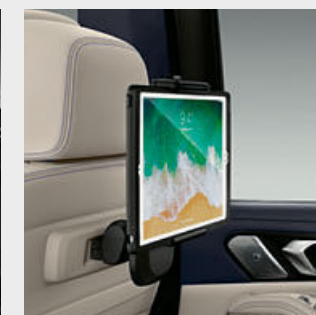

○ Secure hold for tablets with BMW safety case. The adjustable holder is mounted into position into the basic carrier or into the optional Travel & Comfort System.



○ The floating hub cap consists of the BMW logo that no longer turns with the wheel but instead remains level.



○ The high-quality 22" M Performance light alloy wheels Star-spoke style 749 M are weight-optimised with flow forming and designed in Jet Black matt with the M Performance lettering and the colour M logo. TPMS summer complete wheel set, wheel size 9.5J x 22 with tyre size 275/35 R22 104Y XL at the front and 10.5J x 22 with 315/30 R22 107Y XL at the rear.



○ Anti-slip, water-resistant mat for protecting the luggage compartment from dirt and moisture. In black with stainless steel inlay matching the interior.



○ Precisely fitting protection against moisture and dirt in the front footwell. Featuring a black design with a stainless steel inlay, they perfectly complement the interior.

Discover the wide range of innovative solutions available for the exterior and interior, communication and information, and for transportation and the luggage compartment. Your BMW Partner is on hand to advise you on the whole range of Original BMW Accessories and the BMW M Performance Parts product portfolio. For further information, please visit [www.bmw.com](http://www.bmw.com)



BMW X6		xDrive40i <sup>8</sup> with mild hybrid technology	M50i	xDrive30d <sup>8</sup> with mild hybrid technology	xDrive40d <sup>8</sup> with mild hybrid technology
<b>Weight</b>					
Unladen weight EU (xDrive) <sup>1</sup>	kg	2170	2315	2260	2290
Max. permissible weight (xDrive)	kg	2840	2980	2940	2950
Permitted load (xDrive) <sup>2</sup>	kg	745	740	755	735
Permitted trailer load, unbraked (xDrive) <sup>3</sup>	kg	750	750	750	750
Permitted trailer load, braked, max. 12 % gradient/ max. 8 % gradient (xDrive) <sup>3</sup>	kg	3500 <sup>7</sup> /3500 <sup>7</sup>	3500 <sup>7</sup> /3500 <sup>7</sup>	3500 <sup>7</sup> /3500 <sup>7</sup>	3500 <sup>7</sup> /3500 <sup>7</sup>
Luggage capacity	l	580–1530	580–1530	580–1530	580–1530
<b>BMW TwinPower Turbo engine<sup>4</sup></b>					
Cylinders/valves		6/4	8/4	6/4	6/4
Capacity	cm <sup>3</sup>	2998	4395	2993	2993
Max. output/engine speed	kW (hp)/ rpm	245 (333)/ 5500–6250	390 (530)/ 5500–6000	210 (286)/ 4000	250 (340)/ 4400
With mild hybrid technology	kW (hp)	+8 (11)	–	+8 (11)	+8 (11)
Max. torque/engine speed	Nm/rpm	450/1600–4800	750/1800–4600	650/1500–2500	700/1750–2250
<b>Power transmission</b>					
Type of drive		All-wheel	All-wheel	All-wheel	All-wheel
Standard transmission (xDrive)		8-speed Steptronic Sport	8-speed Steptronic Sport	8-speed Steptronic Sport	8-speed Steptronic Sport
<b>Driving performance</b>					
Top speed (xDrive)	km/h	248	250 <sup>6</sup>	235	248
Acceleration (xDrive) 0–100 km/h	s	5.7	4.3	6.1	5.5
<b>Consumption<sup>4, 5</sup> - All engines conform to the EU6 standard</b>					
Low (xDrive)	l/100 km	13.4–12.1	18.6–17.8	9.3–8.7	11.2–9.4
Medium (xDrive)	l/100 km	9.9–8.6	11.9–11.3	7.6–6.3	7.4–6.5
High (xDrive)	l/100 km	9.2–7.8	10.3–9.6	6.9–5.6	6.7–5.8
Extra high (xDrive)	l/100 km	10.6–9.2	11.1–10.2	7.9–6.7	7.9–6.9
Combined (xDrive)	l/100 km	10.4–9.0	12.0–11.2	7.7–6.6	7.9–6.8
Exhaust emissions standard (type-certified)		EU6d	EU6d	EU6d	EU6d
Combined CO <sub>2</sub> emissions (xDrive)	g/km	238–206	275–257	201–172	206–179
Tank capacity, approx.	l	83	83	80	80
<b>Wheels/tyres</b>					
Tyre size		265/50 R19 W	275/40 R21 Y 315/35 R21 Y	265/50 R19 W	265/50 R19 W
Wheel size		9J x 19	9.5J x 21 10.5J x 21	9J x 19	9J x 19
Material		Light alloy	Light alloy	Light alloy	Light alloy

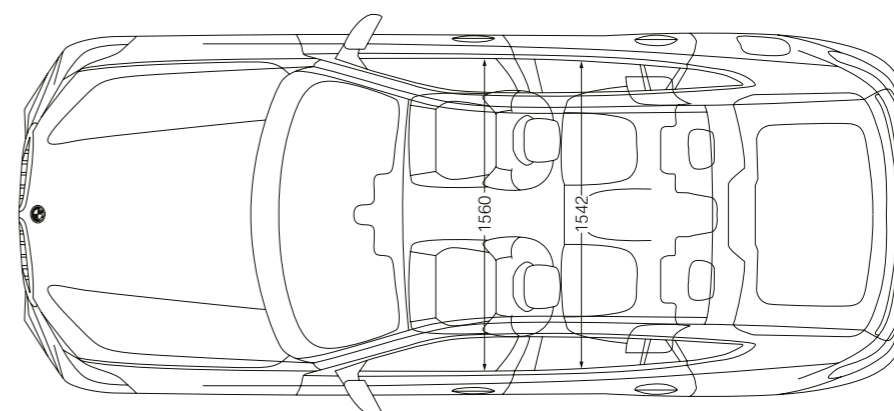
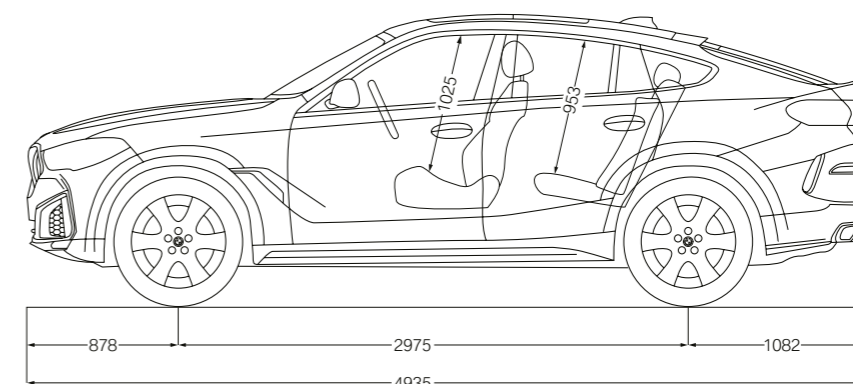
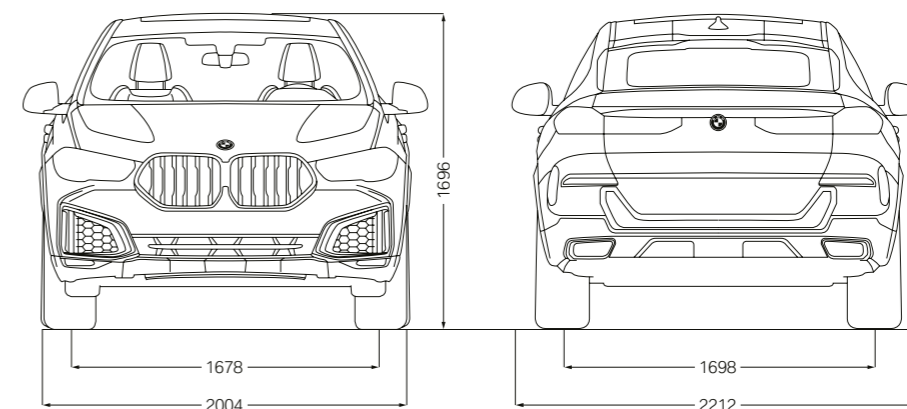

The dimensions in the technical drawing are in millimetres and may vary depending on the model and optional equipment.

- The figures for performance, fuel consumption and CO<sub>2</sub> emissions refer to vehicles with standard transmission.
- <sup>1</sup> The EC unladen weight refers to a vehicle with standard equipment and does not include any optional extras. The unladen weight includes a 90 % full tank and a driver weight of 75 kg. Optional equipment may affect the weight of the vehicle, the payload and the top speed if the selected equipment has an impact on the vehicle's aerodynamics.
  - <sup>2</sup> The actual permitted load depends on the actual unladen weight and the maximum permissible weight of the vehicle (see vehicle registration and type plate on the passenger-side B-pillar) and should be determined by every customer himself. Optional equipment may affect the actual unladen weight and the remaining permitted load.
  - <sup>3</sup> The actual total weight of the trailer must not exceed the maximum permitted trailer load, taking into account the maximum tow bar download.
  - <sup>4</sup> Performance data of petrol engines apply to vehicles using RON 98 fuel. Fuel consumption data apply to vehicles using reference fuels in accordance with EU Regulation 2007/715. Unleaded RON 91 and higher with a maximum ethanol content of 10 % (E10) may also be used. BMW recommends RON 95 super unleaded petrol.
  - <sup>5</sup> Official data for fuel consumption and CO<sub>2</sub> emissions was determined in accordance with the prescribed measuring procedure and corresponds to European Regulation (EC) 715/2007 in the applicable version. For ranges, data determined as per WLTP takes into account any optional equipment (available on the German market in this case). For vehicles that have been newly type approved since 1 January 2021, only the official data according to WLTP exists. For more information about NEDC and WLTP measuring procedures visit [www.bmw.com/wltp](http://www.bmw.com/wltp)
  - <sup>6</sup> Electronically limited.
  - <sup>7</sup> Only with factory-fitted trailer tow hitch.
  - <sup>8</sup> This engine version is not available in all countries. For further information, please contact your local BMW Partner.
  - <sup>9</sup> Provisional figures; any missing figures were unavailable at the time of publication.





## ALL BMW MODELS IN ONE APP.

DOWNLOAD THE **BMW Products** APP NOW AND DISCOVER  
THE PLEASURE OF DRIVING.

### **BMW X6 M50i:**

M TwinPower Turbo 8-cylinder petrol engine, 390 kW (530 hp), 22" M light alloy wheels V-spoke style 747 M Bicolour with mixed tyres, exterior colour in Manhattan metallic, comfort seats for driver and front passenger in BMW Individual full leather 'Merino' | Black, 'Carbon Fibre' M interior trim.

The models illustrated in this medium show the equipment and configuration options (standard and optional) for vehicles produced by BMW AG for the German market. Alterations in standard and optional equipment and the configurations available for the different models may occur after 11/12/2021, the editorial deadline for this medium, or according to the specific requirements of other member states of the European Union. Your local BMW Partner is available to provide further details. Subject to change in design and equipment.

Of course, each vehicle is designed for economical recycling after its long-running life. You can find more information regarding your end-of-life vehicle on our website [www.bmw.de/recycling](http://www.bmw.de/recycling)  
© BMW AG, Munich, Germany. Not to be reproduced wholly or in part without prior written permission of BMW AG, Munich.